

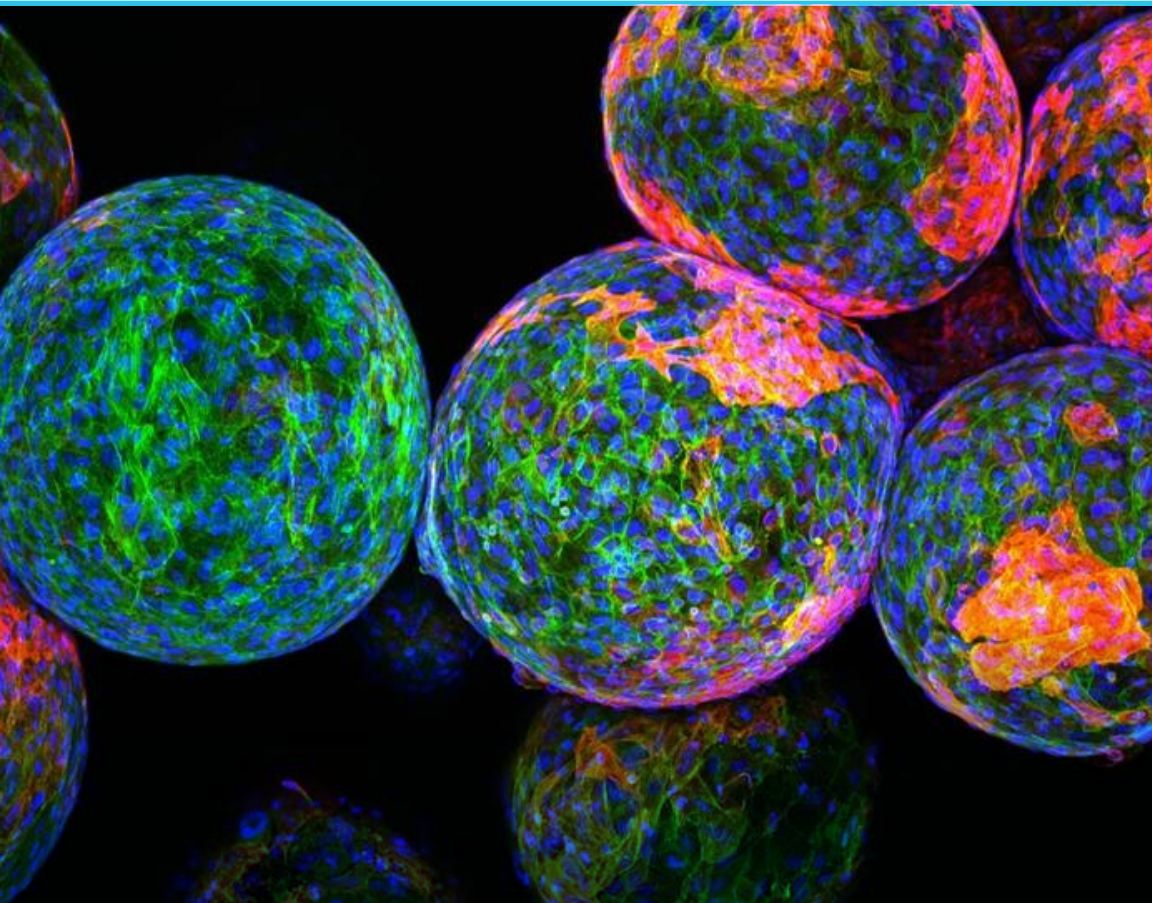

HUMAN ISLET RESEARCH NETWORK (HIRN): YEAR 1 EXECUTIVE SUMMARY REPORT



Credit: Omid Veisheh, Andrew Bader, Arturo Vegas, Anderson/Langer Laboratory, Koch Institute at MIT and Greiner Laboratory (U Mass)

TABLE OF CONTENTS

The Human Islet Research Network: HIRN2

Consortium on Beta Cell Death and Survival (CBDS)..... 6

Consortium on Human Islet Biomimetics (CHIB) 22

Consortium on Modeling Autoimmune Interactions (CMAI) 30

Consortium on Targeting and Regeneration (CTAR)..... 37

THE HUMAN ISLET RESEARCH NETWORK: HIRN

Human islets are small clusters of hormone-producing cells that make up a tiny fraction — less than 2 percent — of the pancreas. One type of cell in the islets, known as the “beta cell,” produces insulin and releases it into a person’s bloodstream when the amount of glucose (sugar) increases. In type 1 diabetes (T1D), those beta cells are destroyed by the immune system, hence the notion of why the disease is referred to as “autoimmune” (i.e., self-directed). Without beta cells, individuals with T1D lose the ability to make their own insulin and must have their insulin provided, either by injections or by a pump. While insulin therapy is lifesaving, it is not a perfect substitute for healthy beta cells, in that sometimes too much or too little insulin is injected. In 2014, the National Institutes of Health (NIH) launched the Human Islet Research Network (HIRN), a new team science effort to better understand why beta cells are lost in T1D and to find new ways to protect or replace beta cells in those with the disease.

HIRN brings together an international group of more than 80 scientists with complementary but diverse expertise and technologies, including cell biology, immunology, microfluidics, advanced imaging, bioengineering, genetics and animal model development. The scientists are organized into four consortia — the Consortium on Beta Cell Death and Survival (CBDS), the Consortium on Human Islet Biomimetics (CHIB), the Consortium on Modeling Autoimmune Interactions (CMAI) and the Consortium on Targeting and Regeneration (CTAR). In its first year, HIRN created infrastructure to facilitate interactions and collaborations among this outstanding group of scientists. For this purpose, a Coordinating Center and Bioinformatics Center, both located at City of Hope in Duarte, California, were established. These centers ensure that information, data, biomaterials, models, protocols, reagents, resources and methods developed by HIRN Investigators are shared in a timely manner to maximize scientific exchange and help accelerate research in the field.

In Year 1, the HIRN consortia took important steps toward achieving the network’s scientific mission. Investigators in the CBDS discovered new markers of the silent disease process before the onset of T1D symptoms that could identify persons whose beta cells are under attack by the

immune system. Using advanced technologies, CHIB Investigators created microenvironments that will greatly improve scientists' ability to derive, grow and study functional beta cells in the laboratory. In the CMAI, investigators began developing the next generation of mouse models to better study the role of the immune system in T1D — “personalized” mice with immune cells and beta cells derived from T1D patient-specific stem cells. Among several avenues of beta cell regeneration research, CTAR investigators identified a small molecule that blocks a protein involved in beta cell death; this molecule is a novel candidate for drug development aimed at regenerating beta cells in human T1D patients. More details about research activities in HIRN's first year are provided in the progress reports for each consortium.

HIRN worked quickly in Year 1 to establish dialogue within and among the consortia, as the success of any team science project depends on fostering regular and robust communication. Regular teleconferences were scheduled for each consortium so that investigators could share research data and challenges in a timely manner. In addition, a Trans-Network Committee (TNC) was established with members from each consortium, the Coordinating and Bioinformatics Center investigators and NIH program staff. The TNC meets monthly to review progress and coordinate interactions across the network, including an annual in-person meeting of all HIRN investigators.

The inaugural HIRN Investigator Meeting was held in May 2015 in Bethesda, Maryland, with 112 attendees, including investigators, co-investigators, postdoctoral fellows and other trainees and HIRN staff. Interested stakeholders from the NIH, JDRF, Leona and Harry Helmsley Charitable Trust and the Network for Pancreatic Organ Donors with Diabetes also participated. This face-to-face meeting was an important step toward building trust and collaboration among the investigators. The meeting provided an opportunity for connections among scientists from different fields — for example, immunology and cell biology — who do not ordinarily attend the same conferences. As these scientists get to know each other, HIRN expects that they will develop innovative research that will propel research in beta cell protection and generation in new directions. By the end of the meeting, several concepts for collaboration within and across the HIRN consortia had been generated, setting the stage for exciting new projects that will accelerate T1D research in Year 2 and beyond. To support this important gathering and promote maximum

participation, the HIRN Coordinating Center received a three-year grant from the Helmsley Charitable Trust to fund a portion of the meeting costs.

Year 1 saw HIRN accomplish another major goal — creating a means of communication with the T1D community and the public at large. The HIRN website (hirnetwork.org), publicly released in March 2015, provides detailed information of the network and its investigators and research projects. Funding announcements, research resources, job opportunities and information about upcoming meetings related to islet and beta cell research are posted for the benefit of diabetes investigators. News stories are posted to keep the general public informed about the latest scientific findings in diabetes research. As the network matures, up-to-date research advances from HIRN investigators will be added to the site.

Finally, in its first year, the HIRN began its efforts to organize transnetwork working groups that capitalize on the diverse expertise and resources available in the four consortia. These include: a translational working group to help HIRN investigators translate results from their basic research into clinical tests that can predict the onset of T1D, a working group to develop a definition of “What is a Beta Cell?”, an Islet Advisory Committee to discuss the use of human islets for basic research, a Website Advisory Group and an Annual Meeting Planning Committee to prepare for the second annual investigator meeting in May 2016.

COORDINATING CENTER (CC) AND BIOINFORMATICS CENTER (BC)

Joyce Niland, Ph.D., CC Principal Investigator, BC Co-Principal Investigator, *City of Hope*

John Kaddis, Ph.D., CC Co-Investigator, BC Principal Investigator, *City of Hope*

Layla Rouse, M.S., CC Project Manager, *City of Hope*

TRANSNETWORK COMMITTEE (TNC) MEMBERS

Mark Atkinson, Ph.D., TNC Chair and CBDS Representative, *University of Florida*

Kristin Abraham, Ph.D., Program Staff, *National Institute of Diabetes and Digestive and Kidney Diseases*

Ashu Agarwal, Ph.D., CHIB Representative, *University of Miami*

Olivier Blondel, Ph.D., Program Staff, *National Institute of Diabetes and Digestive and Kidney Diseases*

Dale Greiner, Ph.D., CMAI Representative, *University of Massachusetts Medical School*

John Kaddis, Ph.D., BC Representative, *City of Hope*

Joyce Niland, Ph.D., CC Representative, *City of Hope*

Alvin C. Powers, M.D., CTAR Representative, *Vanderbilt University*

Sheryl Sato, Ph.D., Program Staff, *National Institute of Diabetes and Digestive and Kidney Diseases*

CONSORTIUM ON BETA CELL DEATH AND SURVIVAL (CBDS)

The signs and symptoms of type 1 diabetes (T1D) — excessive thirst, hunger, tiredness or frequent urination — usually appear very suddenly; new patients are often hospitalized, some with diabetic ketoacidosis, a serious and potentially life-threatening complication. Yet, the disease process that ends with a diagnosis of T1D actually begins months or even years before obvious symptoms occur. This period of “silent” disease development holds important clues to as to why and how beta cells die in T1D and may provide a window of opportunity for stopping the process before the symptoms of diabetes develop. However, research on this period is challenging because the time it takes for the disease to progress to symptoms is highly variable, there is a need for repeated studies of blood samples, and scientists cannot examine the pancreas in living individuals who are at risk for developing T1D because it is located deep within the abdomen.

The Consortium on Beta Cell Death and Survival (CBDS) was created to support new ideas and technologies for studying the silent period of T1D before diagnosis. As but one example of novelty, CBDS members are using new techniques to study single cells or very small groups of cells in the pancreas to find subtle changes in beta cells during the development of diabetes that could be easily missed by looking at large pieces of tissue. Understanding these changes could suggest new treatments to help beta cells survive longer. The consortium is also looking for biomarkers — molecular signs that the beta cells are stressed or dying well before the onset of diabetes symptoms — that could be used as part of a blood test to better identify people who are in the silent period of T1D.

In the first year, CBDS investigators made significant progress in applying new technologies to research on beta cell death and survival. A group led by Ivan Gerling at the University of Tennessee used a technique called “laser microdissection,” in which a laser (a focused beam of light) is used to cut tiny slices of islets from the pancreases of organ donors. By looking at which genes were turned on or off in those slices, they discovered that some islets from a donor with no diabetes and no blood markers suggesting they were at risk for the disease

were similar to islets from a donor who had T1D for several years. This finding suggests that even nondiabetic people may have “sick” islets in the pancreas. Islets from a donor who had been recently diagnosed with T1D were very different from those of the other two donors. Similarly, Wei-Jun Qian of the Pacific Northwest National Laboratory and his team used laser microdissection in combination with their new SNaPP (simple nano-proteomics platform) technology to take an inventory of all proteins found in islets from nondiabetic donors with or without evidence of the silent disease process, as well as donors with established T1D. Both teams are working to identify unique patterns of genes and proteins that can paint a picture of a stressed or dying beta cell at a molecular level.

Other investigators had success identifying potential new biomarkers of the silent pre-T1D process based on molecular changes that happen when beta cells are under stress and begin to die off. Raghavendra Mirmira at Indiana University and an international team of scientists found DNA changes in the blood of newly diagnosed T1D patients that were not present in blood from nondiabetic persons or those with established T1D. Importantly, they discovered the same pattern of DNA changes in urine. Because it is much less invasive to collect urine than blood, this finding could help researchers develop a faster, easier test to identify people who are in the silent period of beta cell death before T1D symptoms. Another team, led by Kevan Herold at Yale University, found changes to a beta cell protein that helps the cell fold insulin into shape. They discovered high levels of an antibody against this protein in the blood of newly diagnosed patients, suggesting that the antibody could serve as a new marker of the silent disease process. They also identified epigenetic changes in beta cells that occur during progression of T1D in NOD mice. Cytokines induced these changes, and similar observations were made with human beta cells. Desmond Schatz of the University of Florida and his colleagues identified DNA and RNA markers from dying beta cells in the blood of newly diagnosed T1D patients and patients with transplanted islets; these markers were not present in blood from individuals without diabetes. In addition, the method was expanded to identify cell death from several different tissues, providing a general platform for the identification of cell death in multiple tissues, in the context of T1D and other pathologies. Doug Melton of Harvard University and his group took a different approach to finding biomarkers

by studying beta cells that were created from human stem cells, rather than using cells from human organ donors. The team transplanted these stem cell-derived beta cells into mice to create a new model for their ongoing research on beta cell stress during the diabetes process.

In Year 1, CBDS investigators accelerated research on beta cell survival and death through their individual projects and also by sharing their technologies and resources across the consortium. For example, Dr. Gerling's group trained other investigators in the islet microdissection technique. Now, several groups can look at microdissected islets from different perspectives and pool their findings to create multidimensional models of islets in health and disease. Dr. Qian's team shared a database they created with information on nearly 10,000 proteins that make up a human islet. This protein map will help the CBDS identify new markers of beta cell stress and death in order to better understand the diabetes process and find new ways to fix it. Finally, in a consortia led by Carmella Evans-Molina, three groups that have developed assays to detect beta cell death *in vivo* initiated a collaborative project to compare data from shared samples from each of the assays.

CBDS INVESTIGATORS

Douglas Melton, Ph.D., Investigator, *Harvard University*

Barak Blum, Ph.D., Co-investigator, *University of Wisconsin*

Raghavendra Mirmira, M.D., Ph.D., Investigator, *Indiana University*

Decio Eizirik, M.D., Ph.D., Investigator, *University of Brussels*

Carmella Evans-Molina, M.D., Ph.D., Investigator, *Indiana University*

Thomas Metz, Ph.D., Investigator, *Pacific Northwest National Laboratory*

Margaret Morris, Ph.D., Co-investigator, *Eastern Virginia Medical School*

Jerry Nadler, M.D., Investigator, *Eastern Virginia Medical School*

Ernesto Nakayasu, Ph.D., Co-investigator, *Pacific Northwest National Laboratory*

Julius Nyalwidhe, Ph.D., Co-investigator, *Eastern Virginia Medical School*

Bobbie-Jo Webb-Robertson, Ph.D., Co-Investigator, *Pacific Northwest National Laboratory*

Wei-Jun Qian, Ph.D., Investigator, *Pacific Northwest National Laboratory*

Rohit Kulkarni, M.D., Ph.D., Investigator, *Joslin Diabetes Center*

Clayton Mathews, Ph.D., Investigator, *University of Florida*

Jason McDermott, Ph.D., Co-investigator, *Pacific Northwest National Laboratory*

Vladislav Petyuk, Ph.D., Co-investigator, *Pacific Northwest National Laboratory*

Tujin Shi, Ph.D., Co-investigator, *Pacific Northwest National Laboratory*

Desmond Schatz, M.D., Investigator, *University of Florida*

Yuval Dor, Ph.D., Co-investigator, *Hebrew University of Jerusalem*

Jorge Ferrer, M.D., Ph.D., Co-investigator, *Imperial College of London*

Ruth Shemer, Ph.D., Co-investigator, *Hebrew University of Jerusalem*

Ivan Gerling, Ph.D., Investigator, *University of Tennessee*

Mark Atkinson, Ph.D., Investigator, *University of Florida*

Martha Campbell-Thompson, D.V.M., Ph.D., Investigator, *University of Florida*

Hao Chen, Ph.D., Co-investigator, *University of Tennessee*

Clayton Mathews, Ph.D., Co-investigator, *University of Florida*

Kevan Herold, M.D., Investigator, *Yale University*

Domenico Accilli, M.D., Co-investigator, *Columbia University*

Mark Mamula, Ph.D., Co-investigator, *Yale University*

“BIOMARKERS OF BETA CELL STRESS IN TYPE 1 DIABETES (BETAMARKER)”

CBDS — *Raghavendra Mirmira, M.D., Ph.D., Decio Eizirik, M.D., Ph.D., Carmella Evans-Molina, M.D., Ph.D., Thomas Metz, Ph.D., Margaret Morris, Ph.D., Jerry Nadler, M.D., Ernesto Nakayasu, Ph.D., Julius Nyalwidhe, Ph.D., Bobbie-Jo Webb-Robertson, Ph.D.*

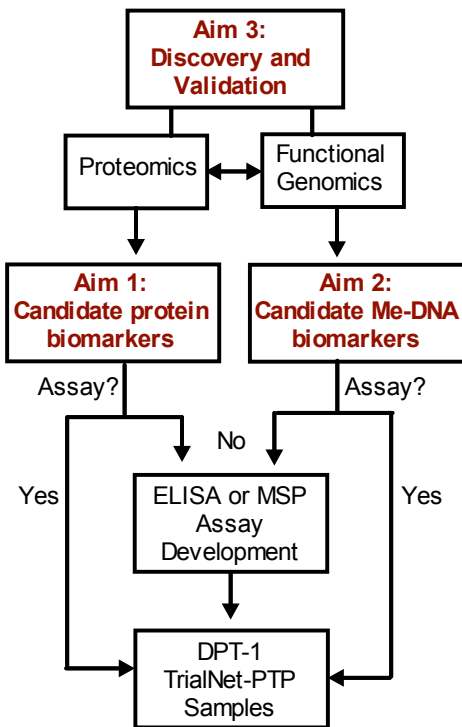

Figure 1. Workflow of the BetaMarker Team of the CBDS. Three aims form the basis of the BetaMarker project team: protein and nucleic acid biomarkers (aims 1 and 2) are being developed by the Evans-

Molina and Mirmira teams, who are testing major candidates (proinsulin and unmethylated *INS*) in clinical samples. The Nadler and Metz teams are using state-of-the-art mass spec technologies to identify new protein candidate biomarkers using human islets and nPOD tissue samples, and the Eizirik team is performing comprehensive functional genomics in humans islets to identify new candidate proteins and nucleic acids. Once new candidates from these "discovery" approaches identified, they are funneled to the Evans-Molina and Mirmira labs for assay development and testing in human samples.

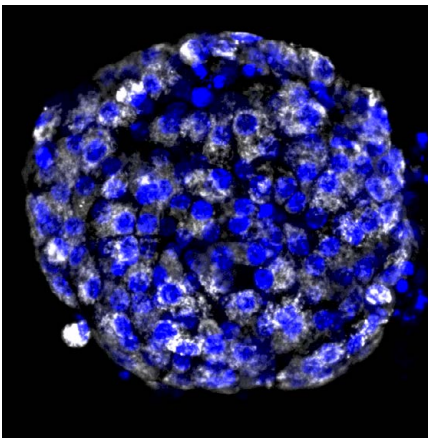
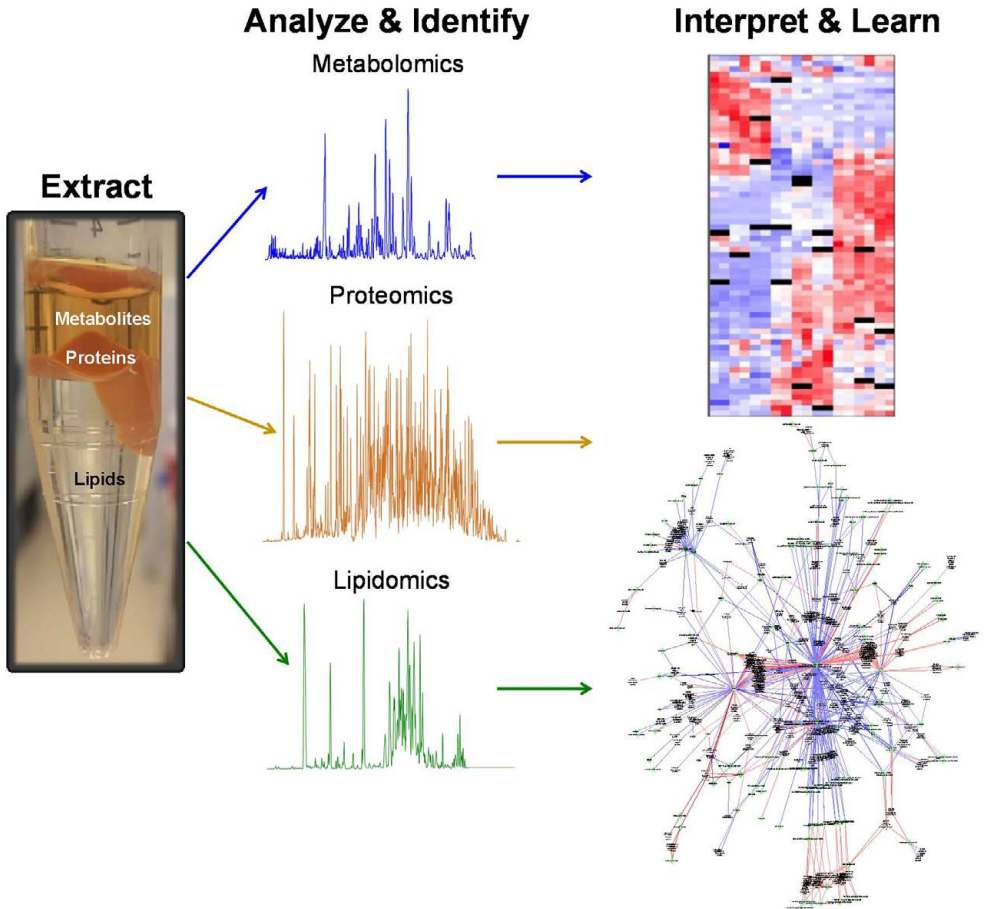

Figure 2. Reactive oxygen species in an islet. Isolated islets were treated with a mixture of cytokines for 12 hours and stained with nuclei (in blue; Hoechst) and reactive oxygen species (in white; CellROX Deep Red reagent).

"REGULATORY NETWORKS AND BIOMARKERS OF BETA-CELL DYSFUNCTION AND APOPTOSIS"

CBDS — *Wei-Jun Qian, Ph.D., Rohit Kulkarni, M.D., Ph.D., Jason McDermott, Ph.D., Vladislav Petyuk, Ph.D., Tujin Shi, Ph.D.*

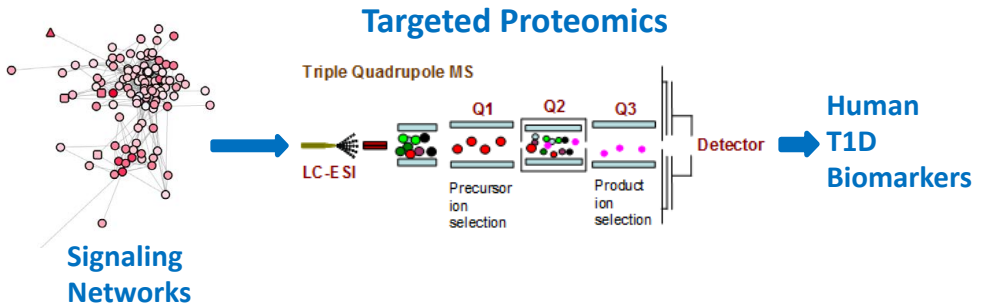

Figure 1. A general schematic for discovering biomarkers for T1D. The workflow initiates from the knowledge of mechanistic signaling networks from human islets to identify candidate biomarkers. The candidates are then verified in tissue and serum by highly sensitive targeted proteomics.

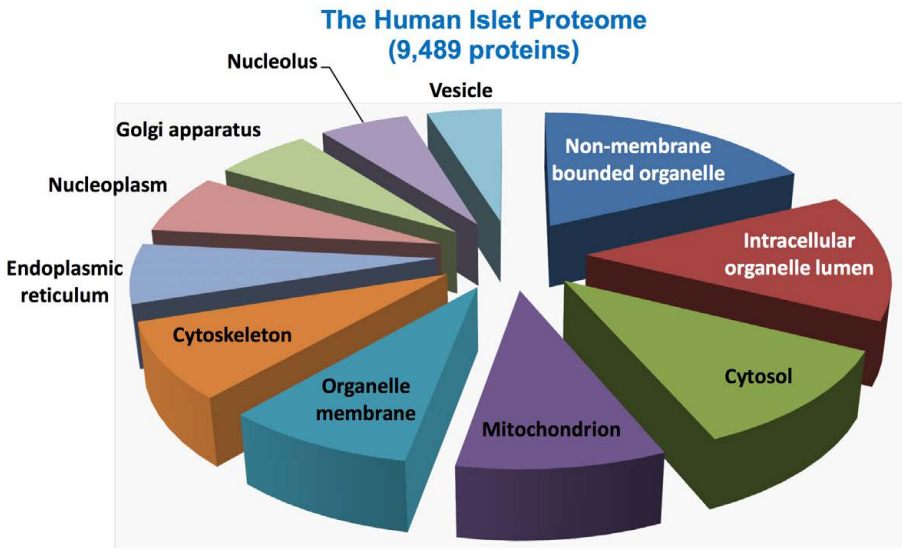

Figure 2. Subcellular distribution of the human islet proteome as profiled by mass spectrometry

Islet-enriched proteins

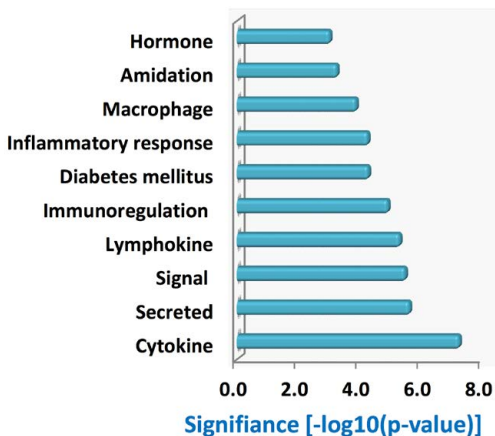

Figure 3. Functional categories of islet-enriched proteins.

“NON-INVASIVE DIAGNOSIS OF HUMAN BETA CELL DAMAGE AND DEATH”

CBDS — *Desmond Schatz, M.D., Yuval Dor, Ph.D., Jorge Ferrer, M.D., Ph.D., Ruth Shemer, Ph.D.*

BETA-CELL-DERIVED DNA IN THE CIRCULATION OF T1D DIABETES PATIENTS

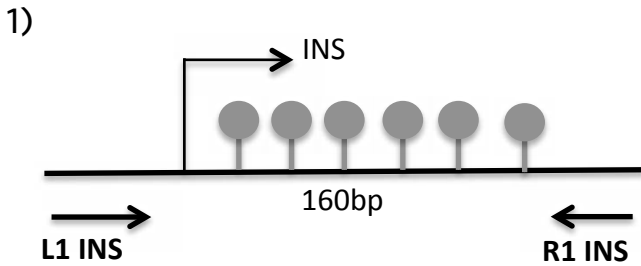

Figure 1. A. Structure of the insulin gene promoter fragment used as a marker. Lollipops represent CpG sites, arrows mark positions of PCR primers.

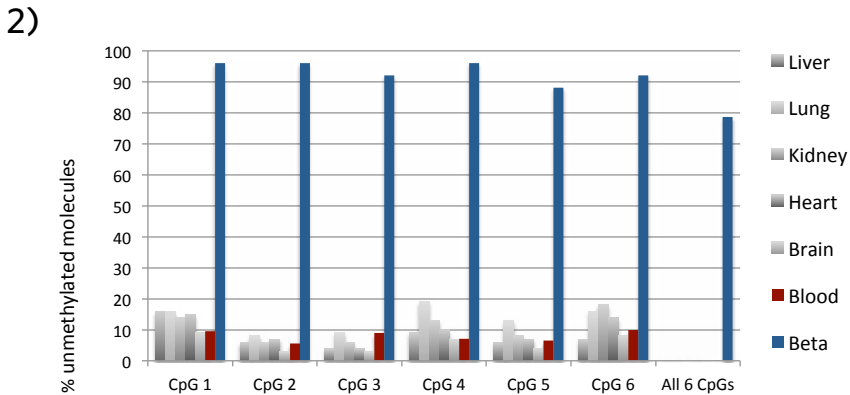

Figure 2. Methylation status of individual CpG sites in the insulin gene promoter in multiple tissues. Graph shows the percentage of unmethylated molecules in DNA from each tissue. The set of columns on the right describes the percentage of molecules in which all 6 CpG sites are unmethylated, demonstrating the increase in signal-to-noise ratio afforded by interrogating all 6 CpGs simultaneously.

3)

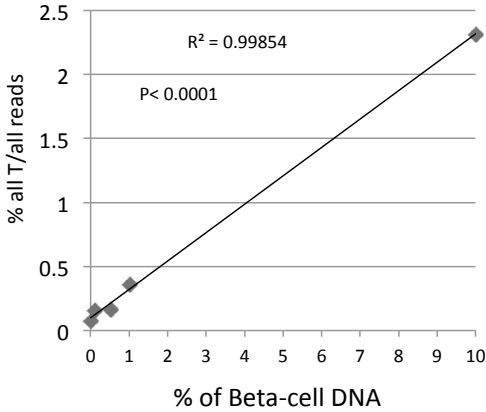
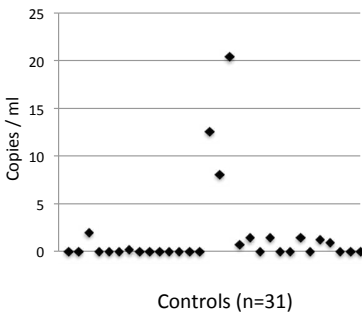

Figure 3. Spike in experiment. Human beta-cell DNA was mixed with human lymphocyte DNA in the indicated proportions (up to 0.1%), and the percentage of fully unmethylated insulin gene promoter (all 6 CpG sites converted by bisulfite to T) was determined.

4)



5)

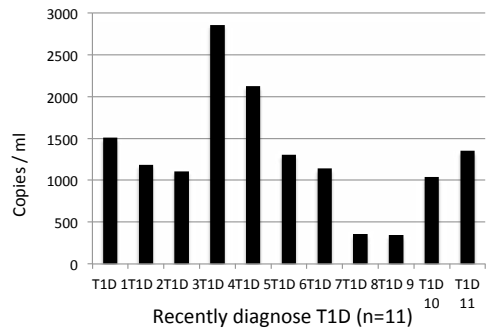

Figure 4. Beta-cell derived DNA in the plasma of healthy controls. The fraction of fully unmethylated insulin promoter DNA molecules (reflective of the fraction of beta-cell derived cfDNA) was multiplied by the absolute level of cfDNA measured in each individual. This value (in ng/ml) was multiplied by 330, to obtain the number of copies of beta-cell-derived insulin genes per ml plasma.

Figure 5. Beta-cell derived DNA in the plasma of recently diagnosed T1D patients. Mann Whitney test for controls vs patients, $p < 0.0001$.

6)

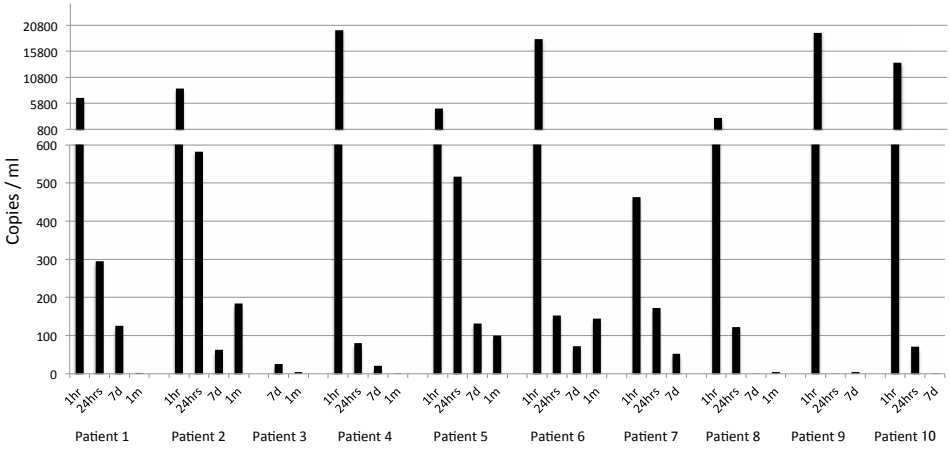
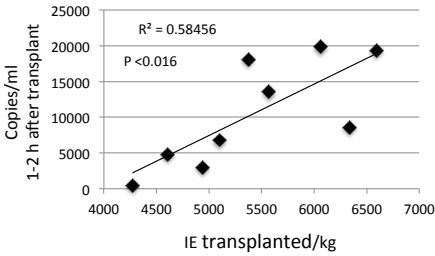

Figure 6. Beta-cell derived DNA in the plasma of long-time T1D patients sampled at the indicated time points after intrahepatic islet transplantation.

7)



8)

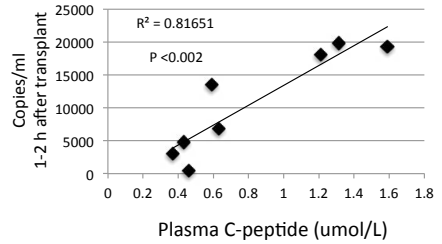

Figure 7. Correlation between the number of transplanted islets (IE, islet equivalents; each islet contains ~1,000 beta cells) per kg and beta-cell cfDNA per ml 1-2 hours after transplantation. N=9 patients.

Figure 8. Correlation between plasma c-peptide levels and unmethylated insulin cfDNA, 1-2 hours after islet transplantation. n=8 patients.

“DEFINING ISLET HETEROGENEITY USING SINGLE ISLET TRANSCRIPTOMICS”

CBDS — *Ivan Gerling, Ph.D., Mark Atkinson, Ph.D., Martha Campbell-Thompson, D.V.M., Ph.D., Hao Chen, Ph.D., Clayton Mathews, Ph.D.*

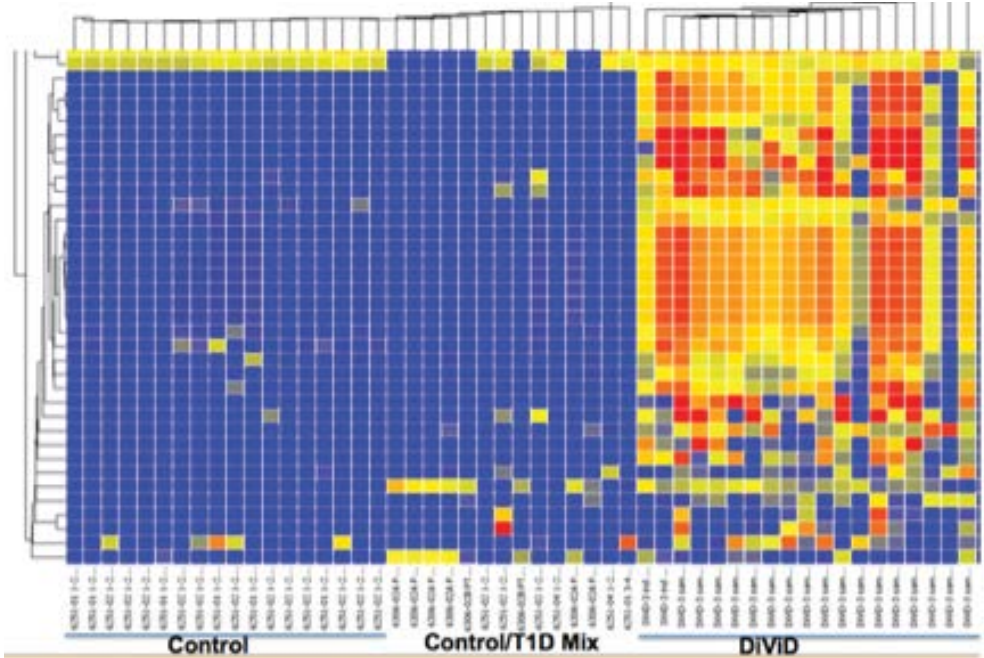

Figure 1. This figure demonstrates relative expression of genes in islets of Langerhans. Each column represents a specific islet and each row the expression of a specific gene — on a color scale of low (blue) to high (red).

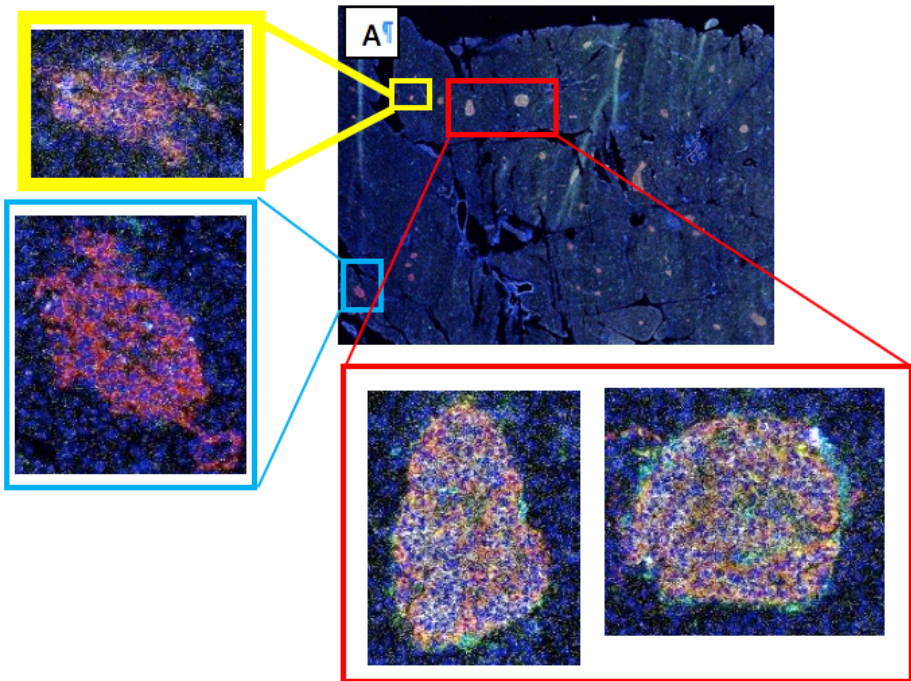

Figure 2. This figure shows a slice of tissue from a human organ donor's pancreas. Staining for presence of insulin and T-lymphocytes help define separate subsets of islets of Langerhans. The gene expression patterns in such islets subsets can then help explain what is different at the molecular level in islets that are normal, nonfunctioning or being attacked by the immune system.

“EPIGENETIC, PROTEIN AND CELLULAR BIOMARKERS OF BETA CELL FUNCTION IN T1D”

CBDS — *Kevan Herold, M.D., Domenico Accilli, M.D., Mark Mamula, Ph.D.*

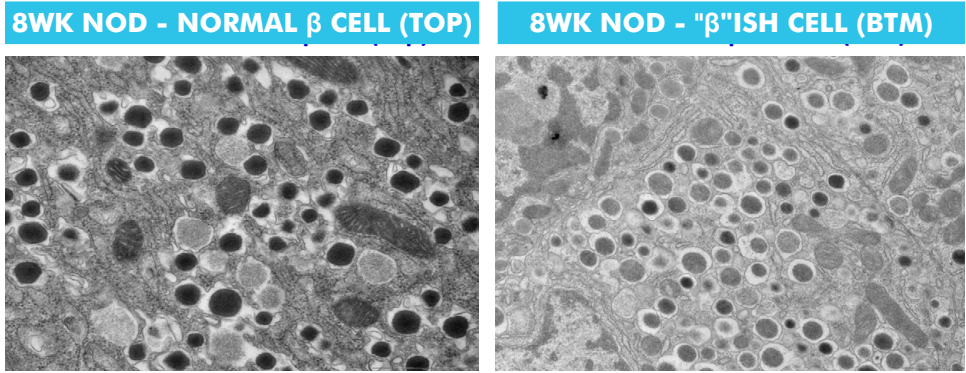

Figure 1. Transitional “beta” cells (vs healthy beta cells) in NOD mice during progression of autoimmune diabetes

(Herold lab)

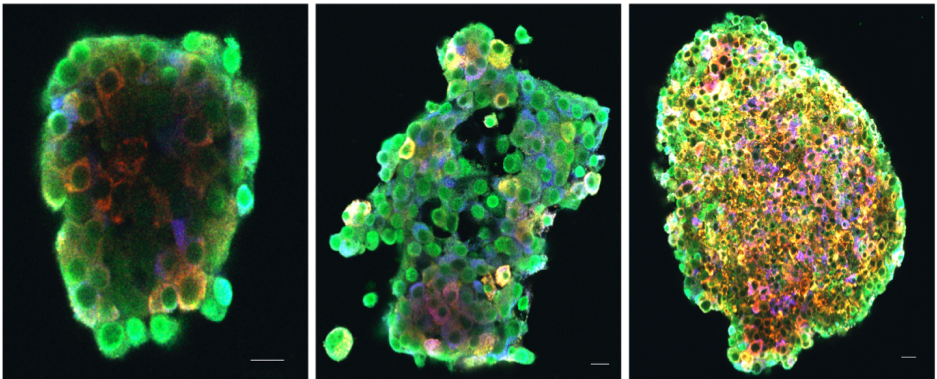

Figure 2. Patients elicit autoantibodies to carbonyl modified P4Hb protein in early T1D prior to immunity to insulin. Moreover, modified P4Hb is increased in human islets under H₂O₂ stress or cytokine stress, as indicated.

Insulin=blue | P4Hb=red | Carbonyl proteins=green

(Mamula lab)

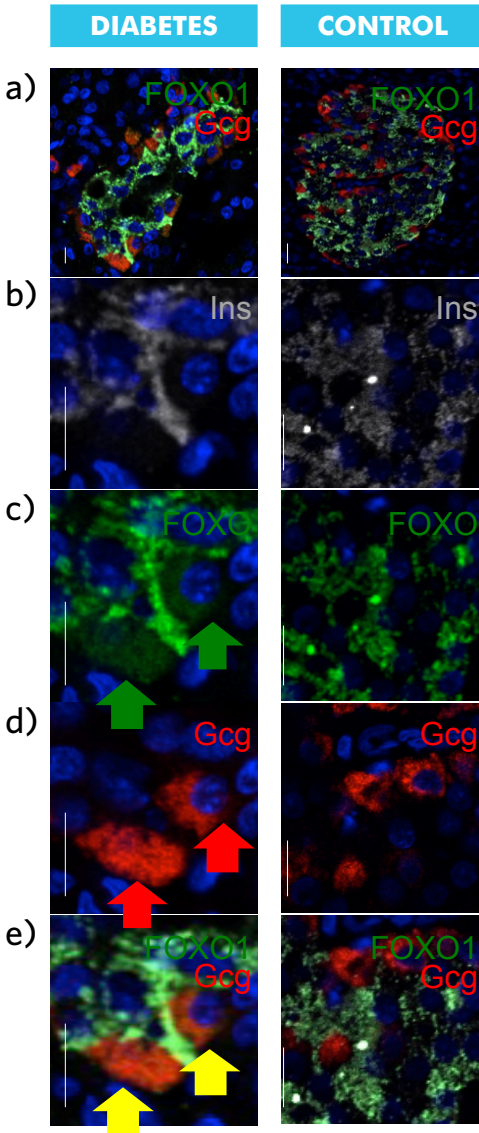

Figure 3. Evidence of alpha/beta cell conversion in diabetes. Immunohistochemistry with Foxo1 (green), Glucagon (red), Insulin (gray) antibodies. A: In non-diabetic controls, Foxo doesn't colocalize with glucagon. B, C: In non-diabetic and diabetic alike, Foxo colocalizes with insulin. D,E: In diabetics there are cells with weak cytoplasmic Foxo immunoreactivity that colocalize with glucagon. These potentially represent former beta cells that have undergone conversion to alpha cells, or (less likely, in our view) alpha cells converting to beta cells.

(Accili lab)

CONSORTIUM ON HUMAN ISLET BIOMIMETICS (CHIB)

In the human body, pancreatic beta cells are finely tuned, complex machines — they sense how much glucose (sugar) is in a person’s blood and, in response, release exactly as much insulin into the bloodstream as the body needs. Beta cells make this calculation over and over, constantly tweaking their work as glucose levels rise and fall when a person eats, moves, sleeps and generally goes about daily life. A grand challenge in diabetes research is to grow human beta cells in the laboratory that mimic how they work in the body. Scientists have successfully used stem cells (cells with the potential to turn into any cell type in the body) to create cells that make insulin. However, these stem-cell derived beta cells are difficult to grow by traditional lab methods and they do not work exactly like beta cells do in the body.

The Consortium on Human Islet Biomimetics (CHIB) was assembled to investigate one of the most important differences between beta cells grown in the lab and beta cells in the human pancreas — the microenvironment. In the lab, cells are usually grown in flat layers without other types of cells, whereas in the body, beta cells are part of a small village of supportive neighbors and services. Beta cells in the pancreas live in three-dimensional “islets” or small clusters with several other types of cells as close neighbors. Blood vessels and nerves weave through the islets like streets, aiding the delivery of food, oxygen, hormones and other signals that help the islet cells grow and work properly. Further, these clusters are housed within 3-D niches that provide mechanical support and deliver signals from the surrounding environment. By recreating the village environment of a human islet in the lab, CHIB scientists hope to turn stem cell-derived beta cells into fully functional beta cells.

In Year 1, CHIB combined the latest advances in beta cell and stem cell biology with state-of-the-art technologies, like microengineering, biofluidics, materials science and microfabrication to begin piecing together islets that look like those found in the body. For example, Douglas Melton at Harvard University and his team of investigators used human stem cells to create alpha cells and delta cells — other types of cells within the islet that release supplementary hormones

in response to changing amounts of glucose in the blood. They are now mixing alpha, delta and beta cells made from stem cells to learn how the cells communicate with each other to create healthy, working islets. Maïke Sander at the University of California, San Diego, and her colleagues are focused on generating a vascular network for the beta cells, so they incorporated fibroblasts and endothelial cells to form tiny blood vessels (microvessels). They grew the microvessels together with human islets in a small device that pumped oxygen through the vessels to support the beta cells located within the ball-shaped islets. Beta cells need a steady supply of oxygen for survival, and islets grown with the microvessels survived in the system for at least one week. They are now determining whether culturing stem cell-derived beta cells together with fibroblasts and endothelial cells improves beta cell function and survival. Another team led by Ben Stanger at the University of Pennsylvania took a combined approach, using both stem cells and blood vessel cells to make precursors of islets (“organoids”). They are now testing combinations of the cells and various chemicals to nudge the stem cells into becoming functional islet cell types, including beta cells.

All of these teams are using their stem cell-created beta cells and human islets in microfluidic devices, tiny machines that allow investigators to precisely control the flow of oxygen and fluids around the islets. With such devices, the investigators can find combinations of nutrients that best maintain islet health and function over long periods of time. For example, by bathing the cells in fluids that contain precise amounts of glucose, they can measure whether the lab-grown beta cells release insulin as well as beta cells do in the body. Another application would be to run a potential new diabetes drug through the device to see whether the drug helps the beta cells work better or if it is toxic. Cherie Stabler of the University of Florida and her collaborators at the University of Miami developed a new microfluidic device and are using it to create an “islet health index.” This index is helping the team learn what the islets need in order to survive and function properly outside of the body. Her team also created a detailed training video to show other laboratories how to construct and operate their own microfluidic devices for human islet research.

Over the past year, CHIB teams communicated through teleconferences and in-person meetings to exchange results and discuss challenges they faced in building human islet systems in the lab. Specifically, the group

discussed challenges in culturing multiple cell types and defining the best markers to characterize a beta cell. They also explored how to share and exchange cells, experimental platforms and assays protocols. Finally, they are collaborating with other HIRN consortia to reduce the cost for common reagents. As these research projects develop, CHIB expects to share with the diabetes research community new tools and technologies for understanding human beta cell health and biology; for studying what goes wrong in the beta cell in type 1 diabetes, type 2 diabetes and other rare forms of diabetes; and for developing new therapies to heal or replace beta cells in human diabetes.

CHIB INVESTIGATORS

Douglas Melton, Ph.D., Investigator, *Harvard University*

Jeff Karp, Ph.D., Co-investigator, *Brigham and Women's Hospital*

Kit Parker, Ph.D., Co-investigator, *Harvard University*

Maïke Sander, M.D., Investigator, *University of California, San Diego*

Karen Christman, Ph.D., Investigator, *University of California, San Diego*

Steven George, M.D., Ph.D., Investigator, *Washington University*

Chris Hughes, Ph.D., Investigator, *University of California, Irvine*

Cherie Stabler, Ph.D., Investigator, *University of Florida*

Ashu Agarwal, Ph.D., Investigator, *University of Miami*

Peter Buchwald, Ph.D., Investigator, *University of Miami*

Camillo Ricordi, M.D., Investigator, *University of Miami*

Ben Stanger, MD, Ph.D., Investigator, *University of Pennsylvania*

Chris Chen, MD, Ph.D., Investigator, *Boston University*

Sangeeta Bhatia, M.D., Ph.D., Investigator, *Massachusetts Institute of Technology*

Paul Gadue, Ph.D., Investigator, *Children's Hospital of Philadelphia*

Kenneth Zaret, Ph.D., Investigator, *University of Pennsylvania*

“ISLET ON A CHIP”

CHIB — *Douglas Melton, Ph.D., Jeff Karp, Ph.D., Kit Parker, Ph.D.*

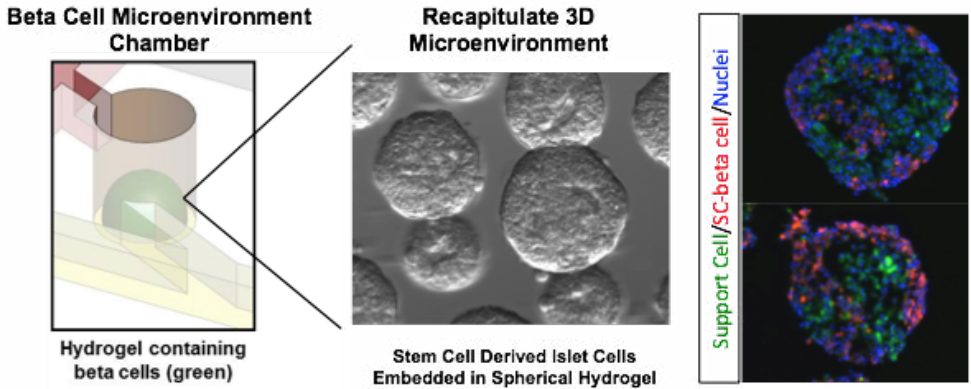

Figure 1. Stem cell derived beta cells (SC-beta cells) exhibit many of the characteristics of the naturally occurring beta cells in the islet and have the potential to improve our understanding of diabetes. To support the survival and long-term study of these SC-beta cells, the Harvard team of researchers is attempting to recreate the native environment of the islet including the surrounding protein matrix (middle) and the inclusion of nonbeta cell from the islet (right). The team is developing microfluidic devices (left) to evaluate the islet organoids.

“A 3D BIOMIMETIC HUMAN ISLET TO MODEL BETA CELL FUNCTION IN HEALTH AND DISEASE”

CHIB — *Maike Sander, M.D., Karen Christman, Ph.D., Steven George, M.D., Ph.D., Chris Hughes, Ph.D.*

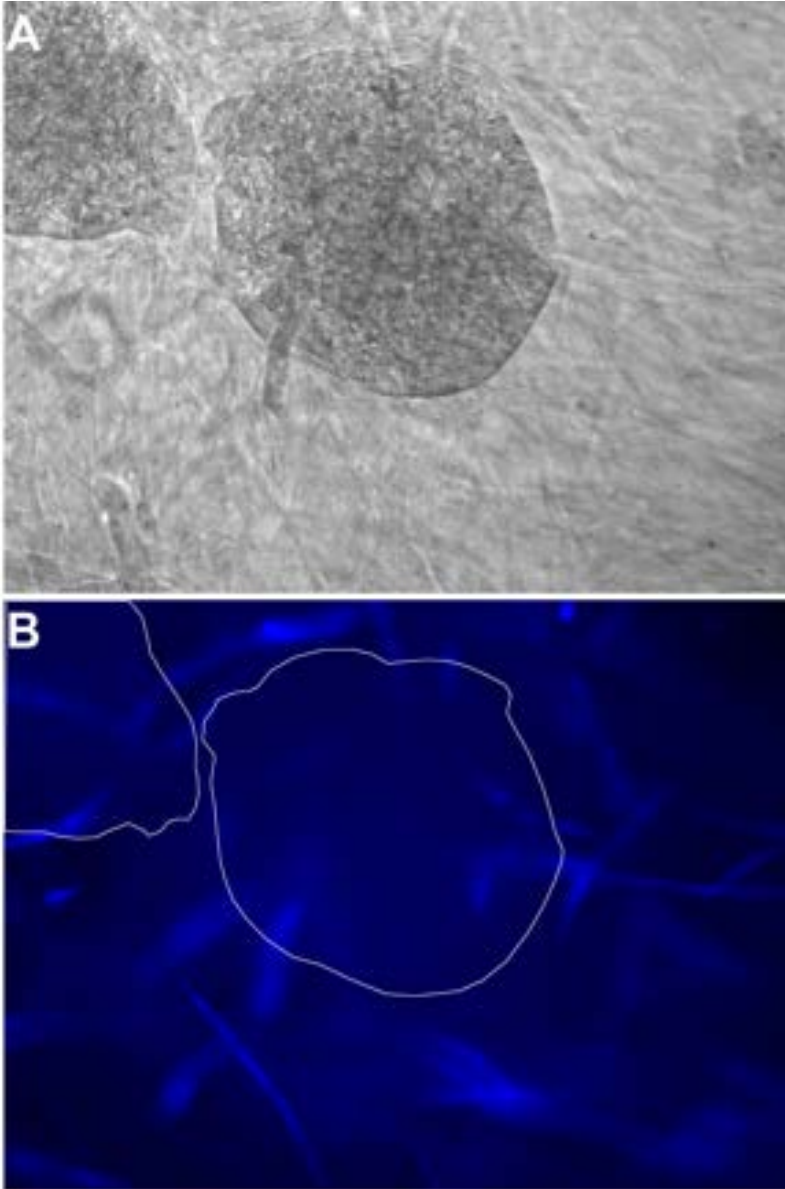

Figure 1. Stem cell-derived human islets (A) are cultured with microvessels (in blue) (B)

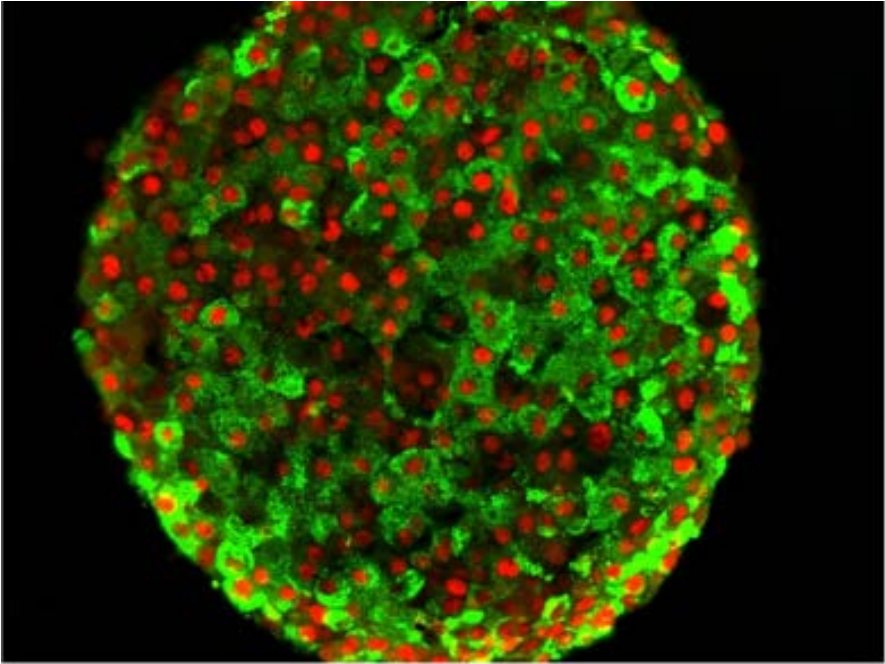

Figure 2. Human stem cell-derived beta cells produce insulin (in green) and mature beta cell markers (in red).

“ENGINEERING A HUMAN PHYSIOMIMETIC ISLET MICROSYSTEM”

CHIB — *Cherie Stabler, Ph.D., Ashu Agarwal, Ph.D., Peter Buchwald, Ph.D., Camillo Ricordi, M.D.*

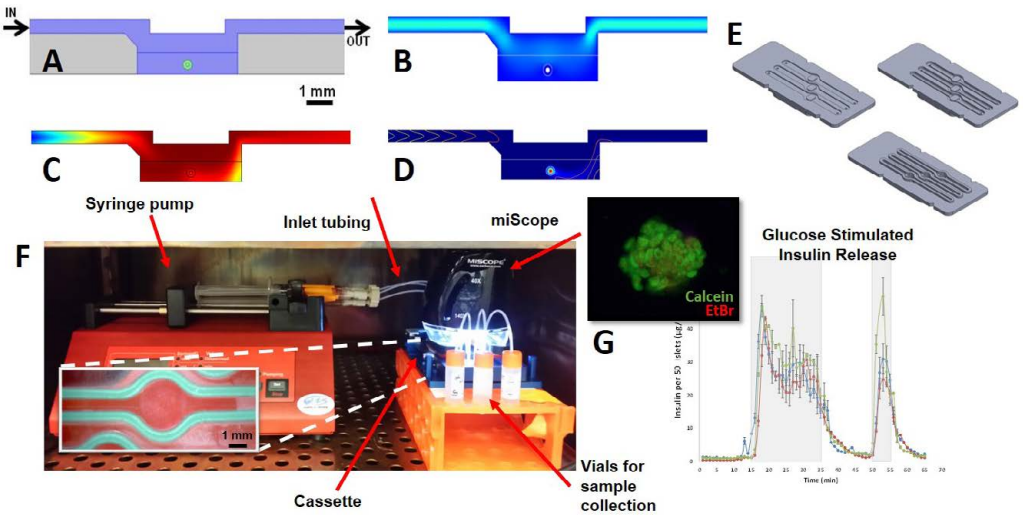
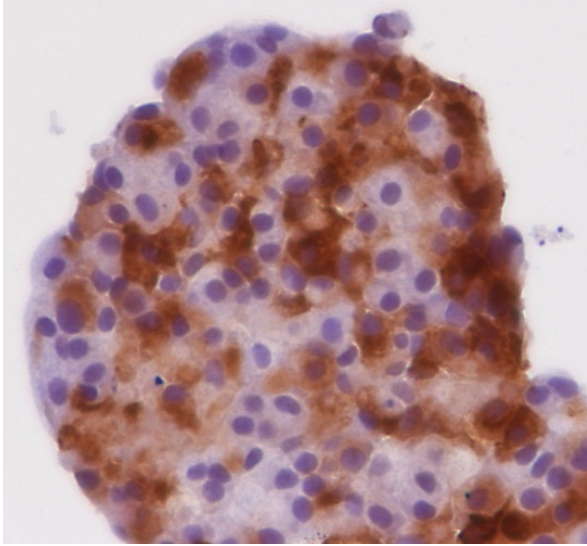

Figure 1. Multiphysics modeling used to optimize the device design. The model incorporates (A) velocity flowfield (B) glucose field (C) and insulin field (D). (E) CAD prototypes emerging from modeling predictions. (F) Current working microchip prototype. (G) Islets within prototype with live/dead confocal image and insulin secretion dynamics.

“A VASCULIZED 3D BIOMIMETIC FOR ISLET FUNCTION AND PHYSIOLOGY”

CHIB — *Ben Stanger, M.D., Chris Chen, MD, Ph.D., Sangeeta Bhatia, M.D., Ph.D., Paul Gadue, Ph.D., Kenneth Zaret, Ph.D.*



C-PEPTIDE STAINING AFTER SIX DAYS

HUMAN S7 CELLS + MSCS + HUVEC

Figure 1. Human embryonic stem cell-derived organoids (Stage 7 cells) stained for cpeptide following co-culture with human mesenchymal stem cells (MSCs) and human umbilical vein endothelial cells (HUVECs). Courtesy Dario Nicetto, Zaret Lab, UPenn.

CONSORTIUM ON MODELING AUTOIMMUNE INTERACTION (CMAI)

Scientists have known for more than 40 years that type 1 diabetes (T1D) is an autoimmune disease — one in which the immune system, which normally protects the body from bacteria, viruses, and other foreign microbes, mistakenly destroys the body's own cells. In T1D, the beta cells in the pancreas are destroyed and the body loses its only source of insulin, a hormone that is essential for life. What remains unknown is what starts the autoimmune process in the first place, why the immune system singles out the beta cells for destruction in some people and what role, if any, the beta cells have in triggering this abnormal response from the immune system. Much research has been done to understand T1D autoimmunity in murine models of the disease. While these studies have provided many clues about the disease process, there are important differences between human and animal immune systems and pancreatic islets. The Consortium on Modeling Autoimmune Interactions (CMAI) is focused on studies of human immunity and pancreatic islets by studying human cells and tissues in culture and in “humanized” mice. The CMAI was established to develop the tools, reagents and resources necessary to build a robust model of the human immune system interacting with genetically matched human islet cells. Ultimately, such models can be used for basic research to unravel the autoimmune process in T1D, as well as for translational research to develop new therapies that stop or reverse the process.

In Year 1, CMAI investigators worked to develop two key components of a model of human T1D. The first is a mouse model with a “humanized” immune system, and the second is a system for creating stem cells from human T1D patients and using those stem cells, in turn, to create genetically identical immune cells, beta cells and other cells involved in diabetes autoimmunity. The combination of a humanized mouse model and patient-specific cells would allow researchers to make more advanced, “personalized” models of the T1D disease process to understand the underlying mechanisms of how human T1D develops.

Dale Greiner of the University of Massachusetts Medical School and a team of investigators developed a “humanized” mouse model that permits the development of human, but not mouse, immune cells that play key roles in diabetes autoimmunity. They also created patient-

specific induced pluripotent stem (iPS) cells that will be used to generate the cells and organs needed to develop insulin-producing beta cells and a complete human immune system in the mouse model. When completed, this model will be used to discover how the human immune system learns to target the human beta cells in patients with T1D.

Megan Sykes at Columbia University led a team that built a humanized mouse model that uses bone marrow stem cells from patients to generate complete immune systems from diabetes patients. They developed personalized beta cells from stem cells derived from the same type 1 diabetic and nondiabetic individuals whose bone marrow generated the immune systems. The team worked to optimize these mice with combined patient-specific humanized immune systems and beta cells. When they put all the pieces together, the team will be able to manipulate and study the immune attack on human beta cells.

Clayton Mathews of the University of Florida and his colleagues used human stem cells and isolated T cells of the immune system to study a gene, called *PTPN22*, that is known to be associated with a person's risk for developing T1D, as well as other autoimmune diseases. When the mutant forms of *PTPN22* are present, there is an increased risk for developing T1D. The mutant forms of this gene alter immune cell function by promoting immune responses, as well as the ability of immune cells to infiltrate tissues and cause damage. A full understanding of how the mutant proteins influence disease will provide a clear path to developing novel therapeutics for T1D and other autoimmune diseases.

At the University of Colorado Denver, Ronald Gill and his team isolated a variety of islet-reactive receptors expressed by human T cells and transferred them into humanized mouse models. Recently, this group has identified such autoreactive T cell receptors isolated from T cells within the pancreas of type 1 diabetic organ donors. Using those models, the team can study how the receptors target human islets for destruction.

CMAI investigators are working together and with other investigators in the HIRN to advance our understanding of T1D autoimmunity. In addition to sharing data and resources within the consortium, the investigators have deposited new mouse models into the Type 1 Diabetes Resource at The Jackson Laboratory for the benefit of the broader T1D research community.

CMAI INVESTIGATORS

Megan Sykes, M.D., Investigator, *Columbia University*

Xiaojuan Chen, M.D., Ph.D., Co-investigator, *Columbia University*

Nichole Danzl, M.D., Co-investigator, *Columbia University*

Dieter Egli, Ph.D., Co-investigator, *Columbia University*

Robin Goland, M.D., Co-investigator, *Columbia University*

Hans Snoeck, M.D., Co-investigator, *Columbia University*

Yong-Guang Tang, M.D., Ph.D., Co-investigator, *Columbia University*

Ronald Gill, Ph.D., Investigator, *University of Colorado Denver*

Peter Gottlieb, M.D., Co-investigator, *University of Colorado Denver*

John Kappler, Ph.D., Co-investigator, *National Jewish Medical and Research Center*

Aaron Michels, M.D., Co-investigator, *University of Colorado Denver*

Maki Nakayama, M.D., Ph.D., Co-investigator, *University of Colorado Denver*

Clayton Mathews, Ph.D., Investigator, *University of Florida*

Todd Brisko, Ph.D., Co-investigator, *University of Florida*

Jing Chen, Ph.D., Co-investigator, *University of Florida*

Alexei Savinov, M.D., Co-investigator, *Sanford Research/USD*

Naohiro Terada, M.D., Ph.D., Co-investigator, *University of Florida*

Mark Wallet, Ph.D., Co-investigator, *University of Florida*

Dale Greiner, Ph.D., Investigator, *University of Massachusetts Medical School*

Rita Bortell, Ph.D., Co-investigator, *University of Massachusetts Medical School*

Michael Brehm, Ph.D., Investigator, *University of Massachusetts Medical School*

David Harlan, Ph.D., Co-investigator, *University of Massachusetts Medical School*

Rene Maehr, Ph.D., Co-investigator, *University of Massachusetts Medical School*

Douglas Melton, Ph.D., Investigator, *Harvard University*

Leonard Shultz, Ph.D., Investigator, *The Jackson Laboratory*

Derrick Rossi, Ph.D., Investigator, *Children's Hospital Corporation*

“MICE WITH AUTOLOGOUS HUMAN T1D-DERIVED IMMUNE SYSTEMS AND IPSC-DERIVED BETA CELLS”

CMAI — *Megan Sykes, M.D., Xiaojuan Chen, M.D., Ph.D., Nichole Danzl, M.D., Dieter Egli, Ph.D., Robin Goland, M.D., Hans Snoeck, M.D., Yong-Guang Tang, M.D., Ph.D.*

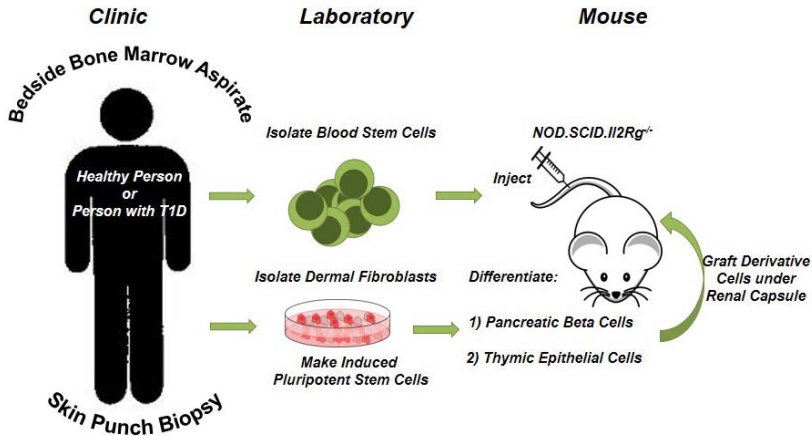

Figure 1. The "Personalized Immune" Mouse: Mice that generate immune systems and beta cells from stem cells of patients with Type 1 diabetes.

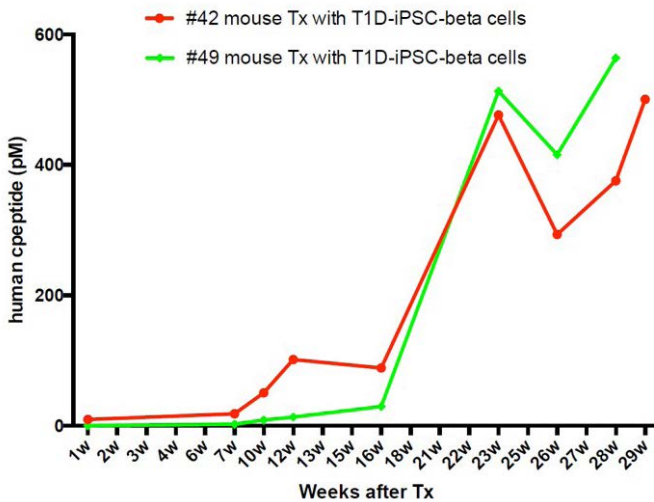

Figure 2. Human insulin is produced in mice given beta cells derived from stem cells of patients with Type 1 diabetes.

“GENETIC REGULATION OF HUMAN BETA CELL DESTRUCTION”

CMAI — *Clayton Mathews, Ph.D., Todd Brisko, Ph.D., Jing Chen, Ph.D., Alexei Savinov, M.D., Naohiro Terada, M.D., Ph.D., Mark Wallet, Ph.D.*

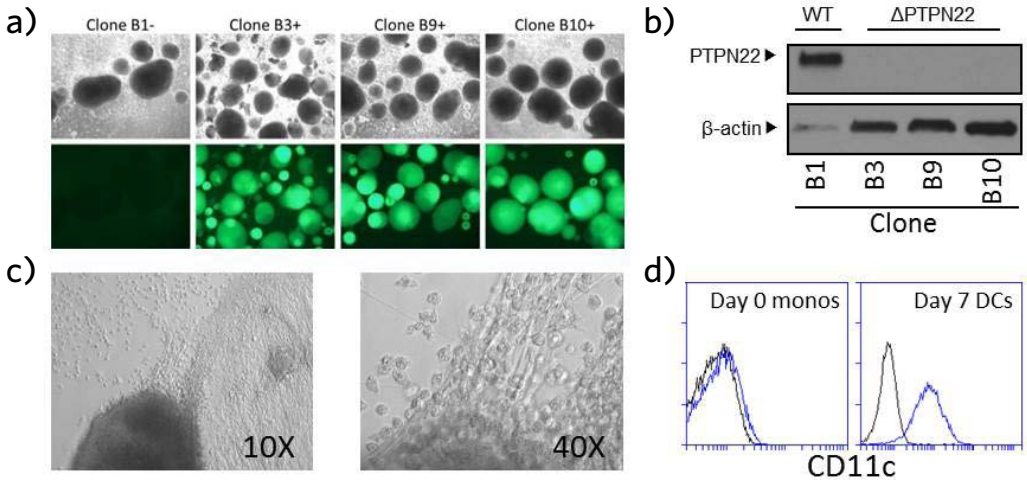

Figure 1. Genetically modified human dendritic cells derived from induced pluripotent stem cells. Human CD34⁺ hematopoietic stem cells were targeted by CRISPR/Cas9 to delete expression of *PTPN22* by delivery of a GFP cassette. **(A)** iPSC colonies were grown into embryoid bodies and CRISPR-modified clones retained GFP expression. **(B)** Gene targeting was confirmed by Western blot to demonstrate loss of *PTPN22* expression at the protein level. **(C)** Embryoid bodies were grown in ‘monocyte factory’ cultures with MCSF and IL-3 to induce differentiation of monocytes. **(D)** Collected monocytes were cultured for 7 days in GM-CSF and IL-4 to differentiate CD11c⁺ immature dendritic cells.

Attribution to Lucas Armitage.

“HUMANIZED MOUSE AVATARS FOR T1D”

CMAI — *Dale Greiner, Ph.D., Rita Bortell, Ph.D., Michael Brehm, Ph.D., David Harlan, Ph.D., Rene Maehr, Ph.D.*

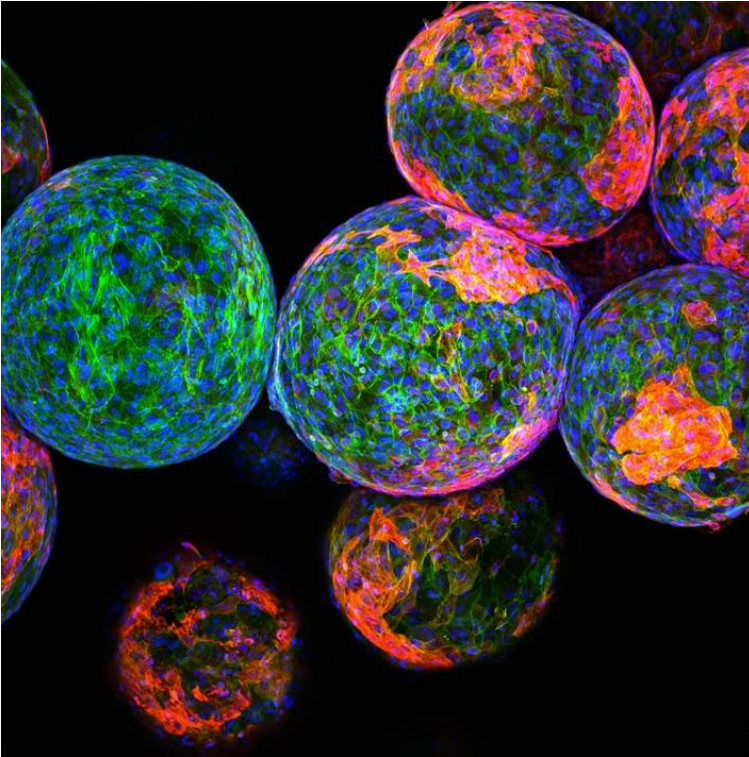

Figure 1. The sugar polymers that make up the spheres in this image are designed to package and protect specially engineered cells that work to produce drugs and fight disease. While on-site, they must remain undetected by the body’s natural defense system. However, the reddish markers on the spheres’ surfaces indicate that immune cells (blue/green) have discovered these invaders and begun to block them off from the rest of the body. Further experiments with the spheres’ geometry and chemistry will lead to better invisibility cloaking and longer lasting protection for these cell-based factories.

Credit: Omid Veisesh, Andrew Bader, Arturo Vegas, Anderson/Langer Laboratory, Koch Institute at MIT and Greiner Laboratory (U Mass)

CONSORTIUM ON TARGETING AND REGENERATION (CTAR)

Every day, millions of people with type 1 diabetes (T1D) or severe type 2 diabetes inject insulin multiple times or use an insulin pump in order to control the levels of glucose (sugar) in their blood. Without enough pancreatic beta cells to produce insulin, these patients depend on daily insulin therapy for life.

The Consortium on Targeting and Regeneration (CTAR) is developing new approaches to diabetes treatment that would free patients from daily insulin therapy — safe, controlled replenishment of working beta cells using the patient’s own cells and tissues. This replenishment — or regeneration — of beta cells could be done by encouraging the few beta cells that remain in some diabetic pancreases to divide and create new copies of themselves. Or, using knowledge gained from stem cells and other avenues of research, nonbeta cell types could be nudged to transform or “reprogram” themselves into new insulin-producing cells. Critically, regenerated beta cells may need to be changed in ways that protect them from the autoimmune process that destroyed the patients’ original beta cells.

In its first year, CTAR investigators approached the problem of islet and beta cell regeneration from several angles. Two teams searched for differences between juvenile and adult beta cells in order to understand why human beta cells lose their ability to replicate themselves during aging. One group found that adult beta cells are missing at least two key proteins (called the prolactin receptor and active STAT5), which prevents adult cells from copying themselves like juvenile beta cells do when exposed to certain signals for cell growth. Another group created a database of gene expression changes in islets from human donors who ranged in age from 3 months to 67 years. Investigators are combing through the database to figure out which proteins might be turned on or off in order to restore replication in adult beta cells.

Alpha cells live next door to beta cells in pancreatic islets and are very similar to beta cells, but they release a different hormone called glucagon, which opposes insulin action and raises blood sugar. A team based at the University of Geneva looked at what is required for glucagon-producing alpha cells to reprogram themselves into insulin-

producing beta cells. The team showed that inserting a protein called PDX-1 into alpha cells was enough to stimulate insulin production in 27 percent (or ~1 in 4) alpha cells. Most of those cells produced both insulin and glucagon, so the team is testing new proteins and combinations of proteins to complete the reprogramming process. Another CTAR team created a series of viruses that specifically infect human alpha or beta cells. By inserting new genes into the cells, these viruses can reprogram the cells, for example to transform alpha cells into beta cells, to restore beta cells' ability to replicate, or to provide immune protection for the beta cells.

Another CTAR team screened a library of 300,000 small molecules to discover molecules that can block a beta cell protein called TXNIP. This protein is known to participate in the process of beta cell death. Inhibition of TXNIP results in less beta cell death, more beta cell mass and higher levels of insulin and provides protection against the development or progression of T1D. The new molecules discovered in Year 1 are strong candidates for drug development aimed at blocking TXNIP action and replenishing beta cells in human T1D.

Collectively, CTAR investigators are sharing reagents, data, ideas and challenges as they explore many promising avenues of beta cell regeneration. Ultimately, the tools, reagents and therapeutic strategies developed by CTAR could lead to new therapies that would release patients from the burden of daily insulin therapy and disease management.

CTAR INVESTIGATORS

Markus Grompe, M.D., Investigator, *Oregon Health & Science University*

Mark Kay, M.D., Ph.D., Investigator, *Stanford University*

Hiroyuki Nakai, M.D., Ph.D., Investigator, *Oregon Health & Science University*

Anath Shalev, M.D., Investigator, *University of Alabama at Birmingham*

Pedro Herrera, Ph.D., Investigator, *University of Geneva*

Kenichiro Furuyama, M.D., Ph.D., Co-investigator, *University of Geneva*

Fabrizio Thorel, Ph.D., Co-investigator, *University of Geneva*

Klaus Kaestner, Ph.D., M.S., Investigator, *University of Pennsylvania*

Benjamin Glaser, M.D., Investigator, *Hadassah-Hebrew University*

Dana Avrahami-Tzfati, Ph.D., Co-investigator, *Hadassah-Hebrew University*

Alvin Powers, M.D., Investigator, *Vanderbilt University*

Andrew Stewart, M.D., Investigator, *Icahn School of Medicine at Mt. Sinai*

Seung Kim, M.D., Ph.D., Investigator, *Stanford University School of Medicine*

Rita Bottino, Ph.D., Co-investigator, *Children's Hospital of Pittsburgh*

Marcela Brissova, M.D., Co-investigator, *Vanderbilt University*

Chunhua Dai, M.D., Co-investigator, *Vanderbilt University*

Peng Wang, Ph.D., Co-investigator, *Icahn School of Medicine at Mt. Sinai*

“IN VIVO TARGETING OF DIABETES-RELEVANT HUMAN CELL TYPES WITH RAAV VECTORS”

CTAR — *Markus Grompe, M.D., Mark Kay, M.D., Ph.D., Hiroyuki Nakai, M.D., Ph.D.*

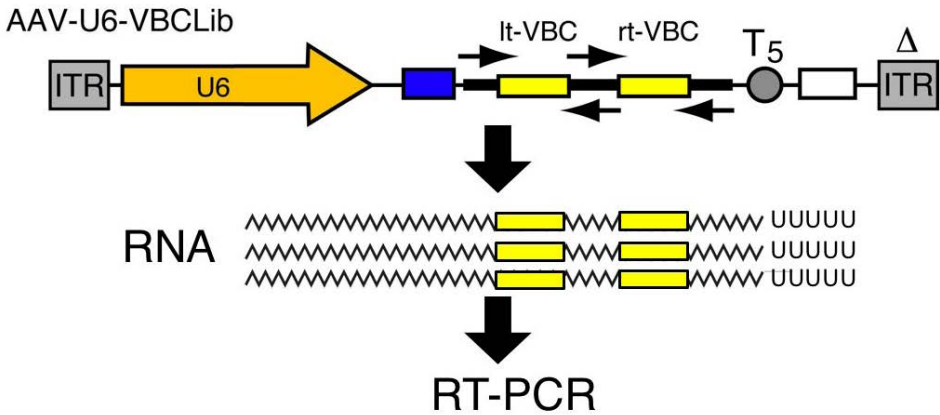

Figure 1. Transduction of beta-cells by AAV capsid libraries is quantitated by measuring the expression of capsid-specific RNA barcodes. Expression is normalized to AAV9 (black bar at the left, set to “1”). Several serotypes yielded expression superior to AAV9.

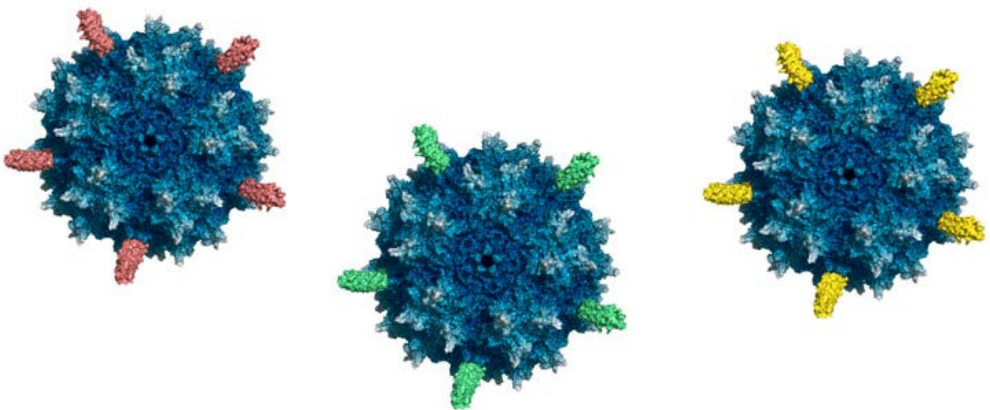

Figure 2. AAV particles with different capsids, illustrated by the different colors.

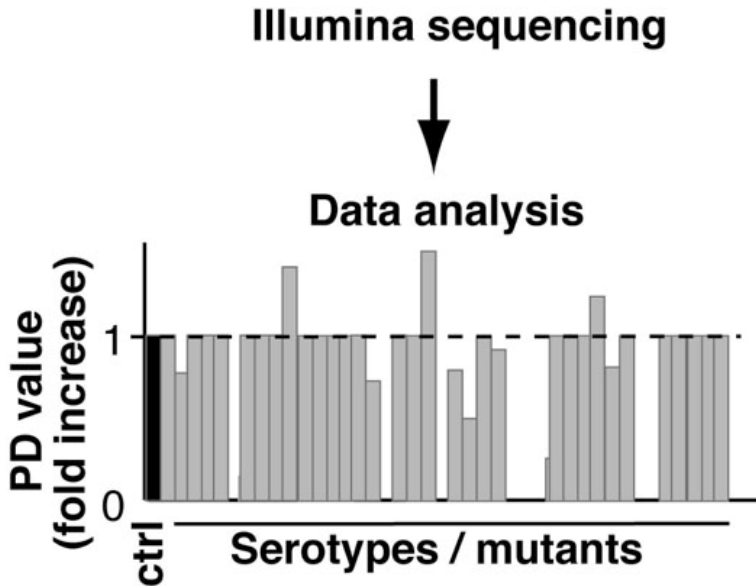

Figure 3. Structure of an AAV genome used for RNA bar code experiments. ITR = AAV inverted terminal repeats, U6: promoter driving RNA expression; there are 2 barbodes, one left (lt-VBC) and one right (rt-VBC); transcription is terminated by a T5 terminator sequence.

“TARGETING TXNIP TO ENHANCE BETA CELL MASS IN T1D”

CTAR — *Anath Shalev, M.D.*

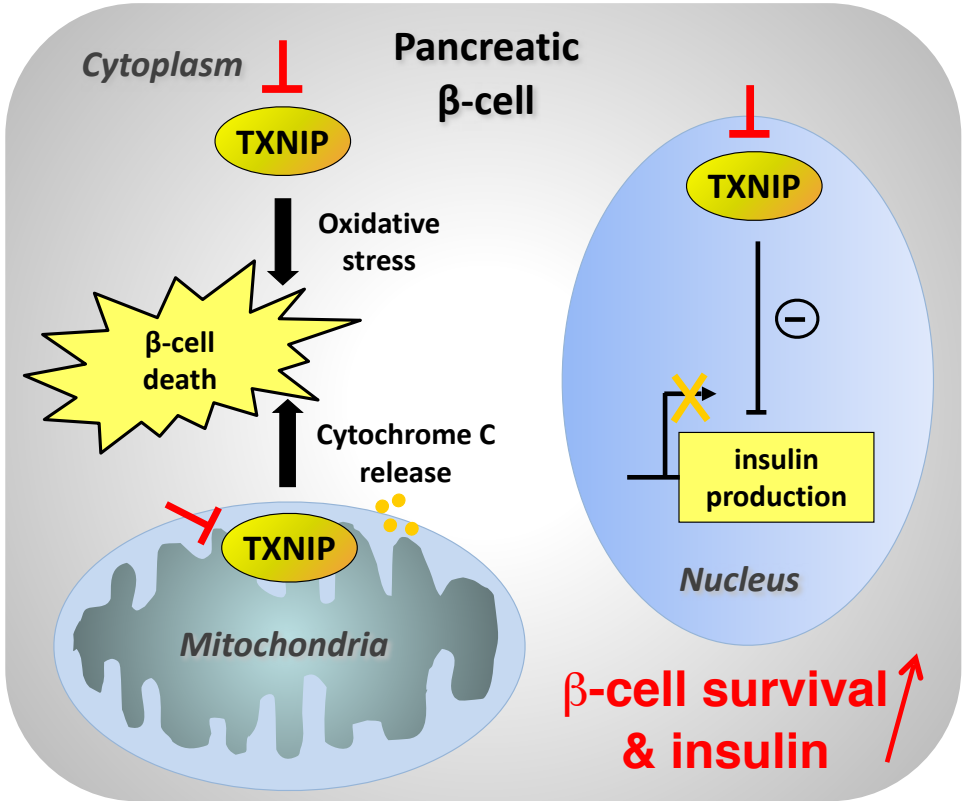
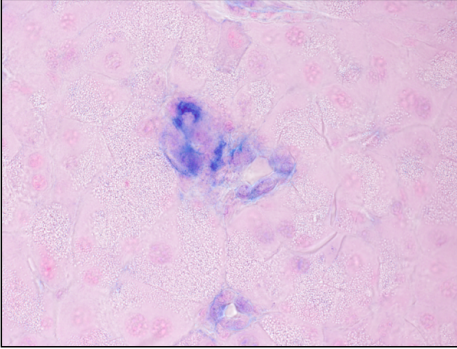

Figure 1. The protein TXNIP acts in different compartments of the pancreatic beta cell. Increased TXNIP levels inhibit insulin production, cause oxidative stress and lead to beta cell death. Inhibition of TXNIP prevents these detrimental effects and promotes beta cell survival and insulin production in the context of T1D.

DIABETES



DIABETES + TXNIP INHIBITION

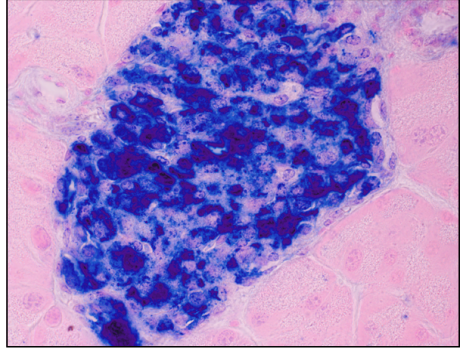

Figure 2. Diabetes leads to loss of insulin (blue) producing beta cells. Inhibition of TXNIP promotes survival of insulin producing islet beta cells.

“BETA-CELL REGENERATION BY ISLET CELL TYPE INTERCONVERSION: EXPLOITING ISLET CELL PLASTICITY FOR DIABETES RECOVERY”

CTAR — *Pedro Herrera, Ph.D., Kenichiro Furuyama, M.D., Ph.D., Fabrizio Thorel, Ph.D.*

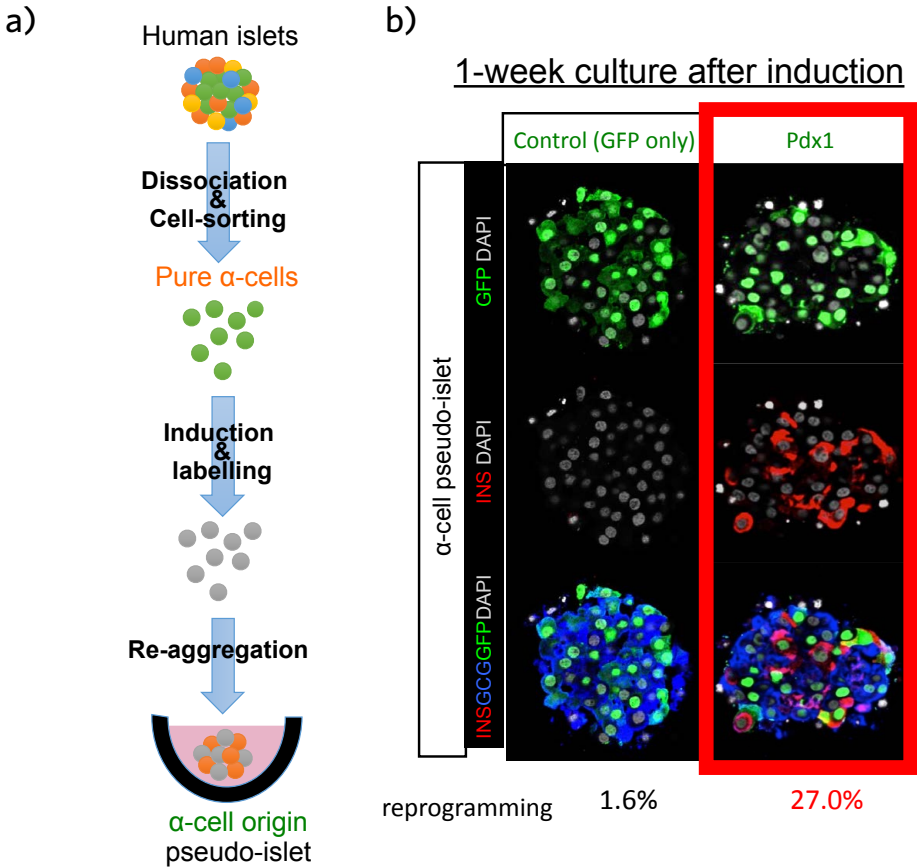

Figure 1. Human glucagon-producing α -cells can reprogram to become insulin-producers.

a. Pure α -cells sorted from human pancreatic islets were transduced with reprogramming factor Pdx1 as well as with GFP reporter protein in order to trace their fate, and then re-aggregated to mimic the 3-D islet architecture; we called these α -cell-only aggregates “pseudo-islets.”

b. One week after culture, one-third of the lineage-traced α -cells transduced with Pdx1 displayed insulin production (red cells).

"MOLECULAR MECHANISMS OF PHYSIOLOGIC β CELL GROWTH IN JUVENILE HUMAN PANCREAS"

CTAR — *Alvin Powers, M.D., Andrew Stewart, M.D., Seung Kim, M.D., Ph.D., Rita Bottino, Ph.D., Marcela Brissova, M.D., Chunhua Dai, M.D., Peng Wang, Ph.D.*

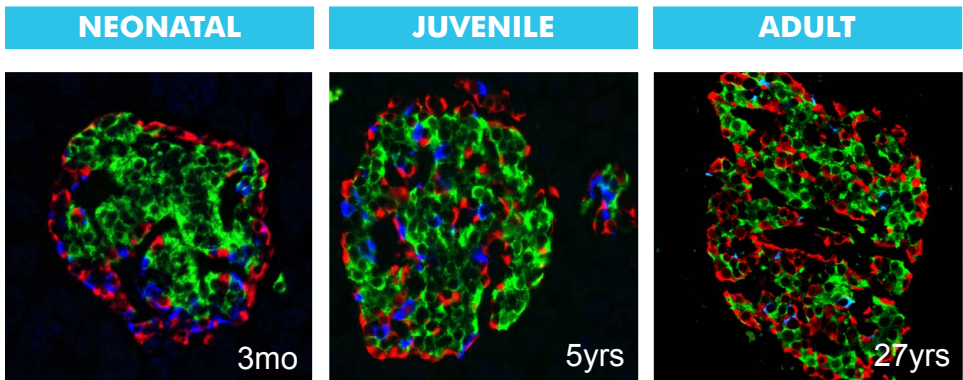

Figure 1. Differences in human islet cell arrangement with age.

An islet in the pancreas of an individual at the age shown in the lower right core of the panel; green - insulin staining, red - glucagon staining, blue - somatostatin staining.

“EPIGENETIC REJUVENATION OF HUMAN BETA-CELLS”

CTAR — *Klaus Kaestner, Ph.D., M.S., Benjamin Glaser, M.D., Dana Avrahami-Tzfat, Ph.D.*

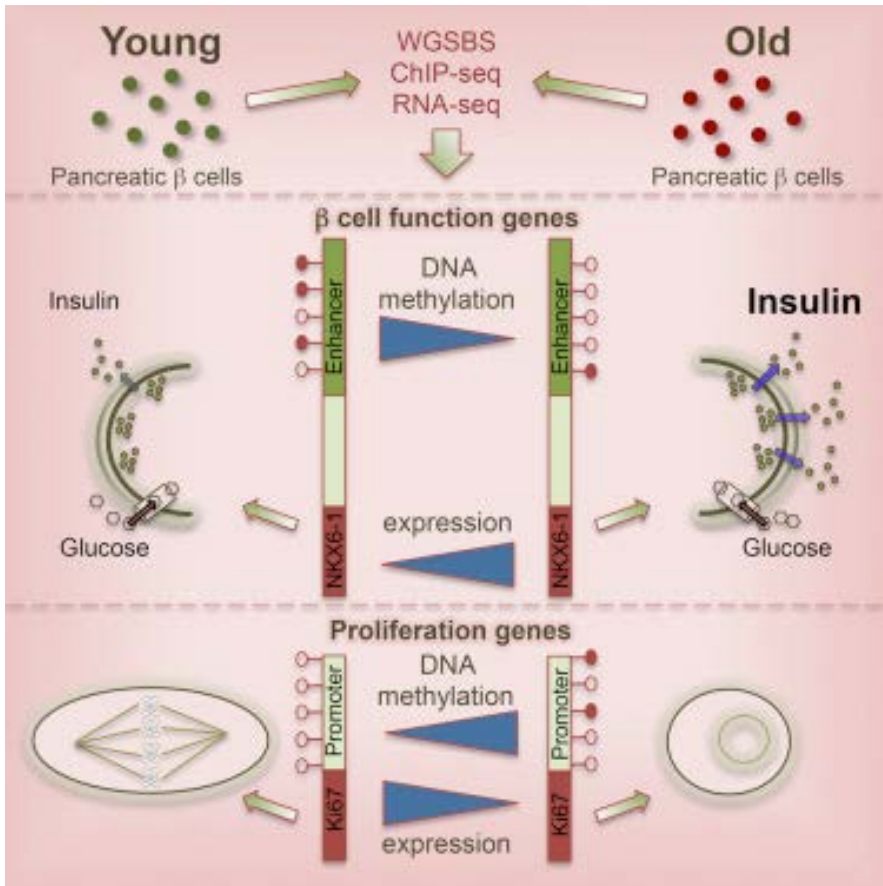

Figure 1. The methylome of human beta cell is dynamic with aging. Most of the changes in DNA methylation occur at enhancer that regulate gene expression in beta cells. Blue color represents low methylation green intermediate, and yellow and orange high levels of DNA methylation. Human beta cells from organ donors ranging in age from 6 months to 60 years were analyzed.

Kaestner lab, unpublished.

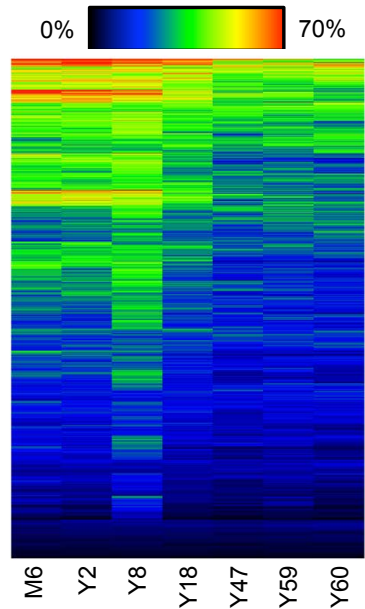

Figure 2. A comprehensive epigenomic analysis of \hat{I}^2 cell aging by Avrahami and colleagues has led to new and sometimes unexpected insights into the biology of aging. The decline in replicative capacity of \hat{I}^2 cells coincides with increased promoter methylation and decreased expression of cell-cycle regulators, possibly making old \hat{I}^2 cells refractory to mitogenic stimulation. This is exactly the opposite scenario of that often seen in cancer, where hypermethylation of tumor suppressor genes makes cancer cells independent of mitogenic stimuli. Surprisingly, our functional analysis revealed improved \hat{I}^2 cell function in older mouse \hat{I}^2 cells, which correlated with and was predicted by the alterations in transcriptome and epigenome with age.

From Avrahami et al., Cell Metabolism, 22:619 [2015]

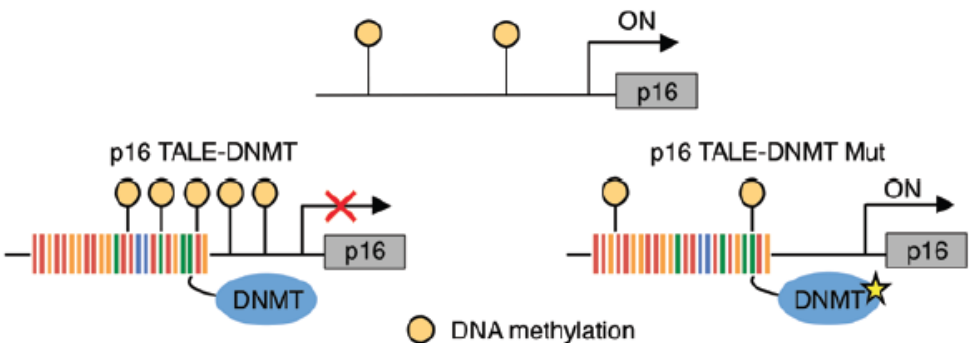

Figure 3. Novel tools allow for epigenetic editing of genes in human cells. In this case, a fusion protein of TALE modules with DNA methyltransferase increases methylation at the gene locus encoding the cell cycle inhibitor p16, resulting in its decrease expression and activation of proliferation.

From Bernstein et al., JCI, 125:1998 [2015]

